

EDS-P308 Series & SPL-24 Hardware Installation Guide

Moxa EtherDevice Switch & PoE Splitter

Fourth Edition, April 2014



© 2014 Moxa Inc. All rights reserved.

P/N: 1802003080013

Overview

We describe two products in this manual:

The **Moxa EtherDevice™ EDS-P308 Series** is an 8-port smart Ethernet switch that provides an economical solution for your Ethernet connections. The switch supports PoE (Power-over-Ethernet) on ports 1 to 4, which means that the EDS-P308 Series can double as a piece of power source equipment (PSE). When used in this way, the EDS-P308 Series can supply up to 15.4 watts of power per port, and can power IEEE 802.3af compliant powered devices (PD), eliminating the need for additional wiring. The EDS-P308 Series switch is highly versatile, and its FX fiber port can transmit data up to 40 km from the device to the control center with high EMI immunity. As an added bonus, the built-in smart alarm function helps system maintainers monitor the health of your Ethernet network.

The **SPL-24** plays the role of PD, and splits the data signal and power signal that are transmitted from the PSE. The SPL-24 plays a dual role of providing power to industrial devices, and enabling Ethernet connections.

The EDS-P308 and SPL-24 have a wide operating temperature range of -40 to 75°C, and are designed to withstand a high degree of vibration and shock. The rugged hardware design makes the EDS-P308 Series and SPL-24 perfect for ensuring that your Ethernet equipment can operate in critical industrial environments, such as in hazardous locations, and complies with FCC and CE standards.

The installation of the EDS-P308 Series is presented on pages 3 to 11. The installation of the SPL-24 is presented on pages 11 to 15.

NOTE Throughout this Hardware Installation Guide, we use EDS as an abbreviation for Moxa EtherDevice Switch, and we use SPL as an abbreviation for Moxa PoE Splitter:

EDS = Moxa EtherDevice Switch

SPL = Moxa PoE Splitter

Wiring Requirements



WARNING

Do not disconnect modules or wires unless the power supply has been switched off or the area is known to be non-hazardous. The devices may only be connected to the supply voltage shown on the type plate. The devices are designed for operation with a Safety Extra-Low Voltage. Thus, they may only be connected to the supply voltage connections and to the signal contact with the Safety Extra-Low Voltages (SELV) in compliance with IEC 60950-1/EN 60950-1.



WARNING

The power for this product is intended to be supplied by a Listed Power Unit, with output marked LPS, and rated to deliver 48 VDC at a maximum of 300 mA.



WARNING

This unit is a built-in type. When the unit is installed in another piece of equipment, the equipment enclosing the unit must comply with fire enclosure regulation IEC 60950-1/EN60950-1 (or similar regulation).



WARNING

Safety First!

Be sure to disconnect the power cord before installing and/or wiring your Moxa EtherDevice Switch. Calculate the maximum possible current in each power wire and common wire. Observe all electrical codes dictating the maximum current allowable for each wire size. If the current goes above the maximum ratings, the wiring could overheat, causing serious damage to your equipment.

You should also pay attention to the following items:

- Use separate paths to route wiring for power and devices. If power wiring and device wiring paths must cross, make sure the wires are perpendicular at the intersection point.
NOTE: Do not run signal or communications wiring and power wiring in the same wire conduit. To avoid interference, wires with different signal characteristics should be routed separately.
- You can use the type of signal transmitted through a wire to determine which wires should be kept separate. The rule of thumb is that wiring that shares similar electrical characteristics can be bundled together.
- Keep the input wiring and the output wiring separated.
- It is strongly advised that you label the wiring to all devices in the system when necessary.

Package Checklist for EDS-P308 Series

The Moxa EDS-P308 Series is shipped with the following items. If any of these items is missing or damaged, please contact your customer service representative for assistance.

- Moxa EtherDevice™ Switch EDS-P308
- Hardware Installation Guide
- Moxa Product Warranty Statement
- Protective caps for unused ports

Features of EDS-P308 Series

High Performance Network Switching Technology

- 10/100BaseT(X) (RJ45)
- 100BaseFX (SC type, Multi/Single mode)
- IEEE802.3/802.3u/802.3x 100BaseFX (SC type, multi-mode, and single-mode)
- Store and Forward switching process type, with 1024 address entries
- 10/100M, Full/Half-Duplex, MDI/MDIX auto-sensing
- Provides up to 15.4 watts per PoE port
- Active circuit protection
- Auto disconnection for over voltage or under voltage
- Power consumption detection and classification

Industrial Grade Reliability

- Power failure, port break alarm by relay output
- Redundant dual DC power inputs

Rugged Design

- Operating temperature range from 0 to 60°C, or extended operating temperature from -40 to 75°C for "-T" models
- IP30, rugged high-strength case
- DIN-Rail or panel mounting ability

Specifications of EDS-P308 Series

Technology	
Standards	IEEE802.3, 802.3u, 802.3x, 802.3af
Forward and Filtering Rate	148810 pps
Packet Buffer Memory	256 KB
Processing Type	Store and Forward, with IEEE802.3x full duplex, back pressure flow control
Address Table Size	1,000 uni-cast addresses
Latency	Less than 5 µs
Interface	
RJ45 Ports	10/100BaseT(X) auto negotiation speed, F/H duplex mode, and auto MDI/MDI-X connection
Fiber Ports	100BaseFX (SC type, multi-mode, and single-mode)
LED Indicators	Power, Fault, FX, 10/100, PoE
DIP Switch	Port break alarm mask
Alarm Contact	One relay output with current carrying capacity of 0.5A @ 48 VDC

Power	
Input Voltage	48 VDC, redundant dual inputs
Input Current	1.6 A (@ 48 VDC)
Connection	Removable "6-pin" Terminal Block
Overload Current Protection	2.5 A (@ 48 VDC)
Reverse Polarity Protection	Present
PoE (per port)	
Minimum output voltage	44 VDC
Maximum output current	350 mA (@ 48V, normal powering mode)
Inrush current	400 to 450 mA (startup mode)
Overload detection	400 mA (max.)
Output current in short circuit condition	400 to 450 mA
Overload and short circuit time limit	50 to 75 ms
Turn off time	500 ms
Turn off voltage	2.8V
Maximum Output Power	15.4W
Mechanical	
Casing	IP30 protection, metal case
Dimensions	53.6 × 135 × 105 mm (W × H × D)
Weight	0.84 kg
Installation	DIN-Rail, Wall Mounting
Environmental	
Operating Temperature	0 to 60°C (32 to 140°F) -40 to 75°C (-40 to 167°F) for -T models
Storage Temperature	-40 to 85°C (-40 to 185°F)
Ambient Relative Humidity	5 to 95% (non-condensing)
Regulatory Approvals	
Safety	UL 508
EMI	FCC Part 15, CISPR (EN55022) class A
EMS	EN61000-4-2 (ESD), Level 3 EN61000-4-3 (RS), Level 3 EN61000-4-4 (EFT), Level 3 EN61000-4-5 (Surge), Level 3 EN61000-4-6 (CS), Level 3 EN61000-4-8 EN61000-4-11
Shock	IEC60068-2-27
Freefall	IEC60068-2-32
Vibration	IEC60068-2-6
WARRANTY	5 years

EDS-P308 Series Panel Layout

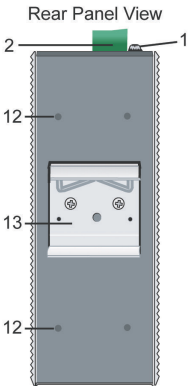
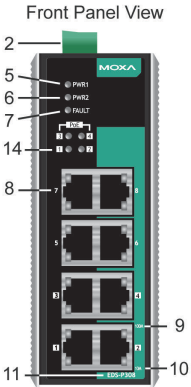
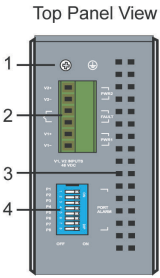

1. Grounding screw
2. Terminal block for power inputs PWR1, PWR2, and relay output
3. Heat dissipation orifices
4. DIP switches
5. Power input PWR1 LED
6. Power input PWR2 LED
7. Fault LED
8. 10/100BaseT(X) Port
9. TP port's 100 Mbps LED
10. TP port's 10 Mbps LED
11. Model Name
12. Screw holes for wall mounting kit
13. DIN-Rail Kit
14. PoE port LEDs (ports 1 to 4)

EDS-P308 (SC-type) Panel Layout

EDS-P308-M-SC
Front Panel View

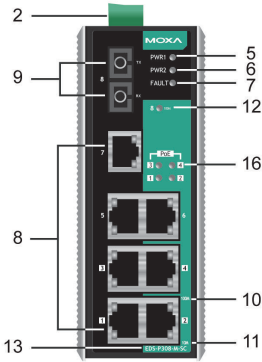

EDS-P308-MM-SC
Front Panel View

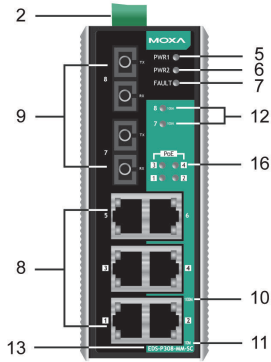

Top Panel View

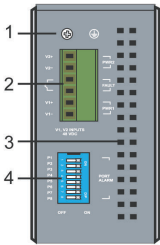

Rear Panel View

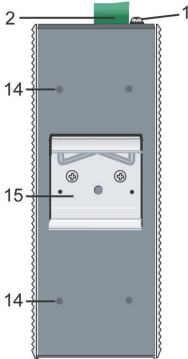

Product models not shown here:

EDS-P308-S-SC is identical to EDS-P308-M-SC.

EDS-P308-SS-SC is identical to EDS-P308-MM-SC.

1. Grounding screw
2. Terminal block for power inputs PWR1, PWR2 and relay output
3. Heat dissipation orifices
4. DIP switches
5. Power input PWR1 LED
6. Power input PWR2 LED
7. Fault LED
8. 10/100BaseT(X) Port
9. 100BaseFX Port (SC type, Multi/Single mode)
10. TP port's 100 Mbps LED
11. TP port's 10 Mbps LED
12. FX port's 100 Mbps LED
13. Model Name
14. Screw holes for wall mounting kit
15. DIN-Rail Kit
16. PoE port LEDs (ports 1 to 4)

NOTE:

MSC: Multi-Mode SC Connector

SSC: Single-Mode SC Connector

Mounting Dimensions

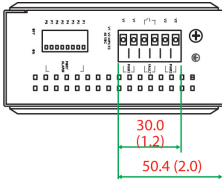

Top View

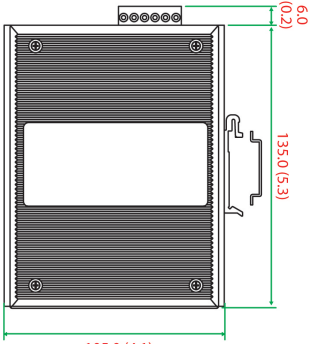

105.0 (4.1)

Side View

DIN-Rail Kit

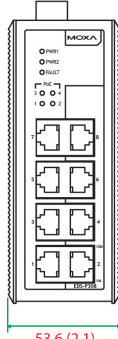

53.6 (2.1)

Front View

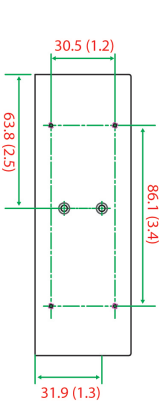

Rear View

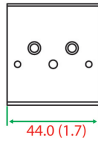

DIN-Rail Kit

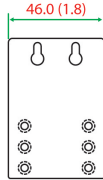

Wall Mounting Kit

5.0 (0.2)

Unit = mm (inch)

DIN-Rail Mounting

The aluminum DIN-Rail attachment plate should already be fixed to the back panel of the EDS-P308 Series when you take it out of the box. If you need to reattach the DIN-Rail attachment plate, make sure the stiff metal spring is situated towards the top, as shown in the figures below.

STEP 1:

Insert the top of the DIN-Rail into the slot just below the stiff metal spring.

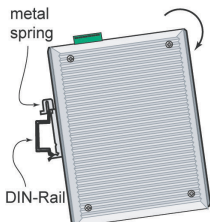

STEP 2:

The DIN-Rail attachment unit will snap into place as shown below.

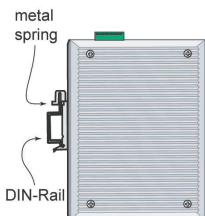

To remove the Moxa EtherDevice Switch from the DIN-Rail, simply reverse Steps 1 and 2 above.

Wall Mounting (optional)

For some applications, you will find it convenient to mount EDS-P308 Series on the wall, as illustrated below.

STEP 1:

Remove the aluminum DIN-Rail attachment plate from the EDS-P308's rear panel, and then attach the wall mount plates, as shown in the diagram below.

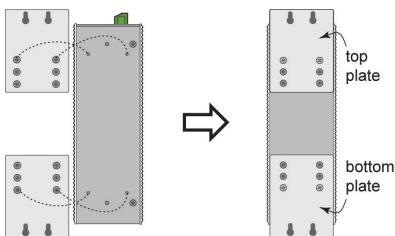

STEP 2: Mounting the EDS-P308 on the wall requires 4 screws. Use the switch, with wall mount plates attached, as a guide to mark the correct locations of the 4 screws. The heads of the screws should be less than 6.0 mm in diameter, and the shafts should be less than 3.5 mm in diameter, as shown in the figure at the right.

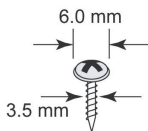

NOTE Before tightening the screws into the wall, make sure the screw head and shank size are suitable by inserting the screw into one of the keyhole-shaped apertures of the wall mounting plates.

Do not screw the screws in all the way—leave about 2 mm to allow room for sliding the wall mount panel between the wall and the screws.

STEP 3:

Once the screws are fixed in the wall, insert the four screw heads through the large parts of the keyhole-shaped apertures, and then slide the EDS-P308 downwards, as indicated. Tighten the four screws for added stability.

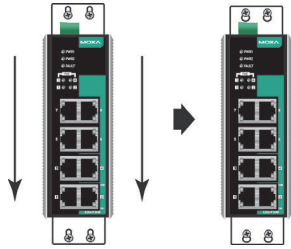

Grounding the EDS-P308 Series

Grounding and wire routing help limit the effects of noise due to electromagnetic interference (EMI). Run the ground connection from the ground screw to the grounding surface prior to connecting devices.



ATTENTION

This product is intended to be mounted to a well-grounded mounting surface, such as a metal panel.

EDS-P308 Series's Redundant Power Inputs

Both power inputs can be connected simultaneously to live DC power sources. If one power source fails, the other live source acts as a backup, and automatically supplies all of EDS-P308 Series's power needs.

Wiring the Redundant Power Inputs

The top two contacts and the bottom two contacts of the 6-contact terminal block connector on EDS's top panel are used for EDS's two DC inputs. Top and front views of one of the terminal block connectors are shown here.

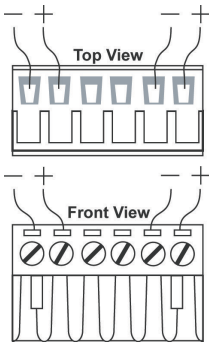

STEP 1:

Insert the negative/positive DC wires into the V-/V+ terminals.

STEP 2:

To keep the DC wires from pulling loose, use a small flat-blade screwdriver to tighten the wire-clamp screws on the front of the terminal block connector.

STEP 3:

Insert the plastic terminal block connector prongs into the terminal block receptor, which is located on EDS's top panel.



ATTENTION

Before connecting EDS to the DC power inputs, make sure the DC power source voltage is stable.

EDS-P308 Series's Alarm Contact

The EDS-P308 Series has one alarm contact located on its top panel. For detailed instructions on how to connect the alarm contact power wires to the two middle contacts of the 6-contact terminal block connector, see the Wiring the Alarm Contact section on page 10. A typical scenario would be to connect the Fault circuit to a warning light located in the control room. The light can be set up to switch on when a fault is detected.

The alarm contact has two terminals that form a Fault circuit for connecting to an alarm system. The two wires attached to the Fault contacts form an open circuit when (1) EDS has lost power from one of the DC power inputs, or (2) one of the ports for which the corresponding PORT ALARM DIP Switch is set to ON is not properly connected.

If neither of these two conditions occurs, the Fault circuit will be closed.

EDS-P308 Series's DIP Switch Settings

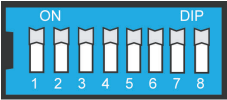

ON: Enables the corresponding PORT Alarm. If the port's link fails, the relay will form an open circuit and the fault LED will light up.

Off: Disables the corresponding PORT Alarm. The relay will form a closed circuit and the Fault LED will never light up.

Wiring the Alarm Contact

The alarm contact consists of the two middle contacts of the terminal block on EDS's top panel. Refer to below for detailed instructions on how to connect the wires to the terminal block connector, and how to attach the terminal block connector to the terminal block receptor. In this section, we explain the meaning of the two contacts used to connect the alarm contact.

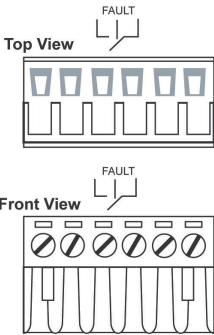

FAULT: The two middle contacts of the 6-contact terminal block connector are used to detect both power faults and port faults. The two wires attached to the Fault contacts form an open circuit when:

1. EDS has lost power from one of the DC power inputs.
- OR
2. One of the ports for which the corresponding PORT ALARM DIP Switch is set to ON is not properly connected.

If neither of these two conditions is satisfied, the Fault circuit will be closed.

LED Indicators

The front panel of the EDS-P308 Series contains several LED indicators. The function of each LED is described in the table below.

LED	Color	State	Description
PWR1	AMBER	On	Power is being supplied to power input PWR1
		Off	Power is not being supplied to power input PWR1
PWR2	AMBER	On	Power is being supplied to power input PWR2
		Off	Power is not being supplied to power input PWR2
FAULT	RED	On	When the corresponding PORT alarm is enabled, and the port's link is inactive.
		Off	When the corresponding PORT alarm is enabled and the port's link is active, or when the corresponding PORT alarm is disabled.
10M	GREEN	On	TP port's 10 Mbps link is active
		Blinking	Data is being transmitted at 10 Mbps
		Off	TP Port's 10 Mbps link is inactive
100M	GREEN	On	TP port's 100 Mbps link is active
		Blinking	Data is being transmitted at 100 Mbps
		Off	100BaseTX Port's link is inactive
FX	GREEN	On	FX port's 100 Mbps link is active.
		Blinking	Data is being transmitted at 100 Mbps.
		Off	100BaseFX Port's link is inactive.
PoE	AMBER	On	Power is being supplied to Powered Device (PD)
		Off	Power is not being supplied to Powered Device (PD)

Package Checklist for SPL-24

The Moxa SPL-24 is shipped with the following items. If any of these items is missing or damaged, please contact your customer service representative for assistance.

- Moxa PoE Splitter, SPL-24
- Hardware Installation Guide
- Moxa Product Warranty Statement

Features of SPL-24

High Performance Network Switching Technology

- IEEE802.3af compliance
- Power/data split from PoE lines using either spare-pairs or data pairs
- Support for up to 12.95 W at 24 VDC
- Support for up to 15.4 watts per PoE port
- Short circuit protection
- Auto disconnection for over voltage or under voltage
- Power consumption detection and classification

Rugged Design

- Operating temperature range from 0 to 60°C, or extended operating temperature from -40 to 75°C for "-T" models
- IP30, plastic case
- DIN-Rail or panel mounting ability

Specifications of SPL-24

Technology	
Standards	IEEE802.3af
Interface	
RJ45 Ports	10/100BaseT(X) for PoE IN, and 10/100BaseT(X) for DATA OUT
LED Indicators	Power
Power	
Input voltage	44 to 75 VDC
Output voltage	24 VDC
Output current	0.54 A @ 24V
Output Power	12.95 W (@ 24VDC)
Connection	Removable "3-pin" Terminal Block for output
Overload current Protection	400 mA (@48 VDC input)
Efficiency	85% (at 25°C, full-loaded)
Mechanical	
Casing	IP30 protection, plastic case
Dimensions	25 × 109 × 88 mm (W × H × D)
Weight	95 g
Installation	DIN-Rail, Wall Mounting
Environmental	
Operating Temperature	0 to 60°C (32 to 140°F) -40 to 75°C (-40 to 167°F) for -T models
Storage Temperature	-40 to 85°C (-40 to 185°F)
Ambient Relative Humidity	5 to 95% (non-condensing)
Regulatory Approvals	
Safety	Pending: UL60950, UL 508, CSA C22.2 No. 60950, EN60950 (pending)
Hazardous Location	UL/cUL Class I, Division 2, Groups A, B, C and D (pending) ATEX Class I, Zone 2, EEx nC IIC (pending)
EMI	FCC Part 15, CISPR (EN55022) class A
EMS	EN61000-4-2 (ESD), Level 3 EN61000-4-3 (RS), Level 3 EN61000-4-4 (EFT), Level 3 EN61000-4-5 (Surge), Level 3 EN61000-4-6 (CS), Level 3
Shock	IEC60068-2-27
Freefall	IEC60068-2-32
Vibration	IEC60068-2-6
WARRANTY	5 years

SPL-24 Panel Layout

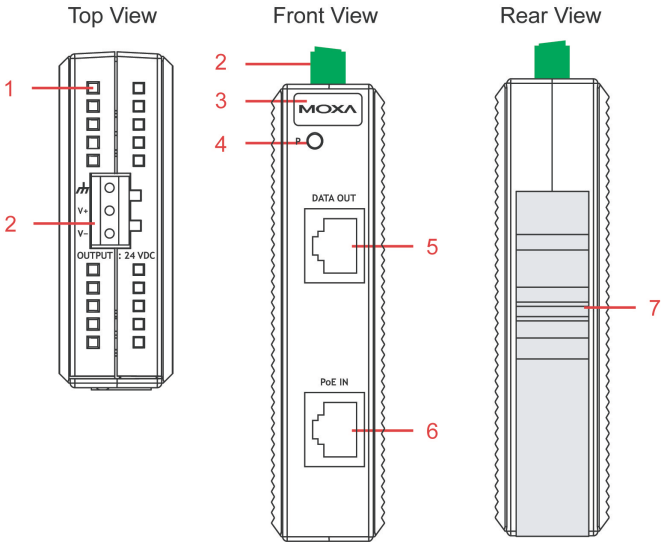

1. Heat dissipation orifices
2. Terminal block for power input and grounding
3. Moxa Logo
4. PoE power LED
5. DATA-OUT port
6. PoE IN port
7. DIN-Rail

Mounting Dimensions

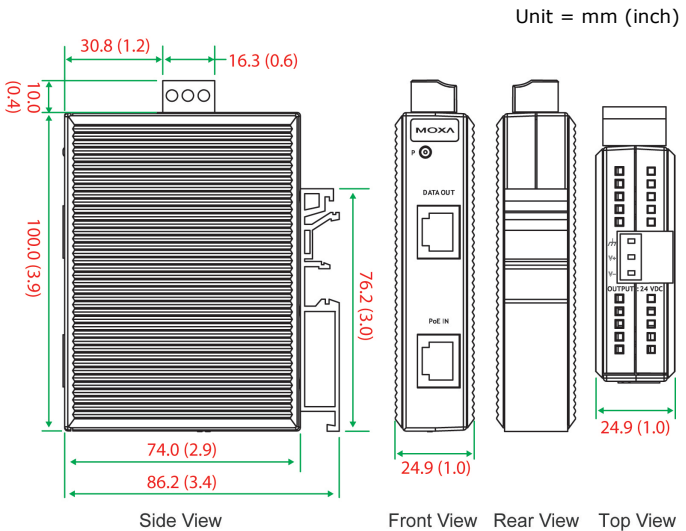

DIN-Rail Mounting for SPL-24

The plastic DIN-Rail attachment plate should already be fixed to the back panel of SPL-24 when you take it out of the box. If you need to reattach the DIN-Rail attachment plate, make sure the stiff metal spring is situated towards the top, as shown in the figures below.

STEP 1:

Insert the top of the DIN-Rail into the slot.

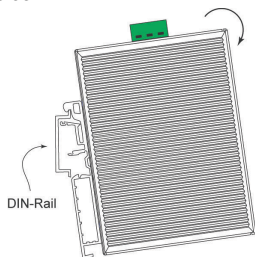

STEP 2:

The DIN-Rail attachment unit will snap into place as shown below.

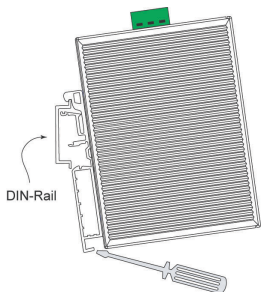
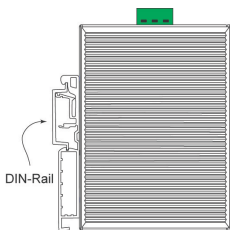

To remove the SPL-24 from the DIN-Rail, insert a flat-blade screw driver horizontally into the DIN-Rail kit under the SPL-24, and then pull it upwards and release SPL-24 towards you away from the DIN-Rail.

Grounding the SPL-24

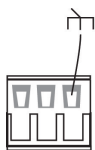

Top View

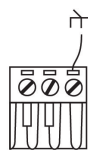

Front View

Grounding and wire routing help limit the effects of noise due to electromagnetic interference (EMI). Run the right most contact of the 3-contact terminal block to the grounding surface prior to connecting devices.



ATTENTION

This product is intended to be mounted to a well-grounded mounting surface, such as a metal panel.

Wiring the SPL-24's Power Outputs

The two left-most contacts of the 3-contact terminal block connector on the SPL-24's top panel are used for 24 VDC output. Top and front views of one of the terminal block connectors are shown here.

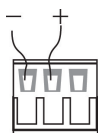

Top View

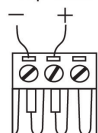

Front View

STEP 1:

Insert the negative/positive DC wires into the V-/V+ terminals.

STEP 2:

To keep the DC wires from pulling loose, use a small flat-blade screwdriver to tighten the wire-clamp screws on the front of the terminal block connector.

STEP 3:

Insert the plastic terminal block connector prongs into the terminal block receptor, which is located on SPL-24's top panel.

Technical Support Contact Information www.moxa.com/support

Moxa Americas:

Toll-free: 1-888-669-2872

Tel: 1-714-528-6777

Fax: 1-714-528-6778

Moxa China (Shanghai office):

Toll-free: 800-820-5036

Tel: +86-21-5258-9955

Fax: +86-21-5258-5505

Moxa Europe:

Tel: +49-89-3 70 03 99-0

Fax: +49-89-3 70 03 99-99

Moxa Asia-Pacific:

Tel: +886-2-8919-1230

Fax: +886-2-8919-1231